



Jet vogne leveres med 5 – 11 skuffer
 Skuffene har plass til 3 – 4 – 5 moduler.
 Standard farge er rød eller mørk grå/sort.
 Spesialfarger på bestilling + 10 %
 Alle vogne hjul 125 mm (M5 160mm)
 H. 971 x D. 546 X L.M3-774/M4-964/M5-1154mm



JET.6M3/GM3 **7900,-**



JET.7M3/GM3 **8900,-**



JET.8M3/GM3 **9 900,-**



JET.9M3/GM3 **10 500,-**

JET.6M4/GM4 **9700,-**

JET.7M4/GM4 **10 000,-**

JET.8M4/GM4 **10 800,-**

JET.9M4/GM4 **11 400,-**

JET.6M5/GM5 **13 500,-**

JET.7M5/GM5 **14 000,-**

JET.8M5/GM5 **14 400,-**

JET.9M5/GM5 **14 950,-**



JET.C4M3/GM3 **6750,-**



JET.C4M4/GM4 **7500,-**

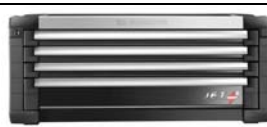

JET.C4M5/GM5 **8850,-**



JET.6M4
m.toppkasse
JET.C4M4

Høyde toppkasse 480 mm



JET.5M3/GM3 **7500,-**



JET.11M3/GM3 **13 500,-**
Høyde 1325 mm



Spesialfarger på bestilling
+ 10 %, minimum 6 stk.



JET.T6M3 **13 800,-**



FAS.21BK **25.000,-**
L.1166 x B.500 x H.1660 mm
Topp og bunn kan kjøpes separat
FAS.13BK **15000,-** FAS.C8BK **11000,-**



Jetline er tilpasset Facom modulsystem



Se det store utvalg av fast verkstedinnredning.
Last ned brosjyre på vår hjemmeside.

Alle priser netto ekskl.MVA. 06/17

NICOM A/S
Stålfjæra 5
0975 OSLO

Tlf.: 22 666 777
Fax: 22 666 770

www.nicom.no
www.smarttools.no
e-mail: nicom@nicom.no

			
	Treplate JET.A14M3 480,-	Verktøypanel JET.A6M3 1290,-	
	JET.A14M4 650,-	JET.A6M4 1535,-	
JET.A13XL 585,- Dokumentholder	JET.A14M5 810,-	JET.A6M5 1650,-	JET.A3 1050,- Svingbart bord for PC etc.
			
JET.A5GXL 1695,- Rengjøringssett, komplett Bord, papirholder, avfallsbeholder	JET.A5-1GXL 1010,- Papirholder m.bord	JET.A5-2XL 860,- Avfallsbeholder	JET.A-3GXL 395,- Papirholder
			
JET.A1GXL 520,- Flaskekurv	JET.A2GXL 380,- Dokumentholder	JET.A8GXL 1550,- Sideskap, låsbart	JET.A11 575,- Verktøykasse
			
JET.A9M 825,- Tyverisikring		JET.A8/A8GPOWER 6500,- Sideskap m. strømtilkopling for ladestasjoner etc.	

Alle priser netto ekskl.MVA. 06/17

NICOM A/S
Stålfjæra 5
0975 OSLO

Tlf.: 22 666 777
Fax: 22 666 770

www.nicom.no
www.smarttools.no
e-mail: nicom@nicom.no





			
MODM.CPE3 1130,-	MODM.CPE2 1175,- 181.25CPE-185.20CPE- 192.16CPE-980C	MODM.HLA 1225,- 3/8" J.HLA 7 – 11MM 1/2" S.HLA 12 – 19MM	MODM.J2 1495,- 3/8" pipesett,
			
MODM.JL1 1575,- 3/8" pipesett, skralle JL.161 JH 8-19,21-22 mm J.210-215-240A-120A-232- 235	MODM.JL2 1575,- 3/8" pipesett, JL.171 skralle JH8-19,21-22 mm J.210RC-215RC-240A-120A- 232-235	MODM.JL2U 3995,- 3/8" pipesett, JL171 skralle + skralle nøkkelsett ser. 65, tommemål 13 piper 1/4" – 1" kort, 11 piper 1/4" – 7/8" lang J.210RC-217RC, 65.PE bitskralle,7 skralle nøkler 1/4x5/16-5/16x11/32-3/8x7/16- 1/2x9/16-5/8x11/16-3/4x13/16-7/8x15/16	
			
MODM.J5 1600,- 3/8" pipesett, J.360 skralle JH8-19,21-22 mm J.210RC-215RC-240A-120A- 232-235	MODM.MI3 1070,- 205H.50-208A.32CBA- 263.20-256.6 248.4-5-6mm	MODM.MI4 1150,- 202H.40-208A32CBA- 263.20-256.6-248.4-5-6	MODM.MI7 1140,- 205C.50-208A32CBA- 263.18-256.6-248.4-5-6
			
MODM.NJ1 1095,- 3/8" kraftpiper 6-19 mm NJ.210A-211A-240A Låserringe og stifter		MODM.PCSN 1095,- 177A.13 – 18 179A.13 – 18	MODM.PR.12 990,- 181.25CPE – 580.10

Alle priser netto ekskl.MVA. 09/16

NICOM A/S
Stålfjæra 5
0975 OSLO

Tlf: 22 666 777
Fax: 22 666 770

www.nicom.no
www.smarttools.no
e-mail: nicom@nicom.no

			
MODM.467RJ12 2730,- 12 Rapid skrallfastnøkler 8 - 19 mm	MODM.467RJ14 3200,- 14 Rapid skrallenøkler 8 - 24 mm	MODM.603F 2035,- 603F, 660S.10, 893.316, 237.S, 5 filer 200mm m. skaft	
			
MODM.501A 1095,- 2 griptenger 501A - 501AMP	MODM.A1 750,- 8 Protwist skrutrekkere AN3,5X75-3,5X100-4X100- 5,5X100 AWH6,5X150-8X175 ANP1X100-2X125	MODM.A2 750,- 8 Protwist skrutrekkere AN2X75-2,5X75 ANP0X75-AWPH3X150 AND1X100-2X125-3X150	MODM.A3 720,- 8 Protwist skrutrekkere AN4X25-5,5X35 ANP0X75-1X25 AND0X75-1X100-2X35-2X125
			
MODM.A4 775,- 9 Protwist skrutrekkere AN2,5X75-3,5X75-4X35-4X100- 4X300-5,5X35-5,5X100 AWH6,5X150-8X175	MODM.A5 785,- 10 Protwist skrutrekkere ANP0X75-1X25-1X100-2X35- 2X125-2X250-3X150 AND1X100-2X125-2X35	MODM.A6 895,- 10 Protwist skrutrekkere, Torx® AEX6X35-7X35-8X75 ANXR10X75-15X75-20X100- 25X100-27X100-30X125-40X150	MODM.A7 1150,- AN4x100, 5.5x150, AWH8x175, AND1x100, 2x125, ANP0x75 82H.JP8A, 89.JP8A
			
MODM.ANXR 740,- 7 Protwist skrutrekkere, Torx® ANXR10X75-15X75-20X100- 25X100-27X100-30X125-40X150	MODM.CG 1160,- 11 dorer-kjørner m.grep 249.G2-3-4-5-6-8 247.G4-5-6-8, 255.G6	MODM.CPE 940,- 185.20CPE-187.18CPE- 192.16CPE	MODM.CPE1 1475,- 181.25CPE-185.20CPE- 192.16CPE-501

Alle priser netto ekskl.MVA. 06/17

NICOM A/S
Stålfjæra 5
0975 OSLO

Tlf.: 22 666 777
Fax: 22 666 770

www.nicom.no
www.smarttools.no
e-mail: nicom@nicom.no















			
MODM.64J7 1750,- 7 rette skrallenøkler 6x7,8x9,10x11,12x13, 1415,16x18,17x19	MODM.64JU6 1650,- 6 flate ringskrallenøkler 1/4x5/16 3/8x7/16-1/2x9/16- 5/8x11/16 3/4x13/16-7/8x15/16	MODM.65J7 2250,- 7 skrallenøkler 15° 6x7,8x9,10x11,12x13, 1415,16x18,17x19	MODM.65JU6 2145,- 6 vinklede ringskrallenøkler 1/4x5/16 3/8x7/16-1/2x9/16- 5/8x11/16-3/4x13/16-7/8x15/16
			
MODM.75 1310,- 13 rørnøkler, vinklet 7 – 19 mm	MODM.84TZX 675,- 7 unbrakonøkler m.kule 3-4-5-6-7-8-10mm	MODM.89TX 695,- 7 Torx® nøkler T10-15-20-25-27-30-40	MODM.99B 2850,- 7 lange leddet T-nøkler 7-8-10-11-13-17-19 mm
			
MODM.440-1 1375,- 17 komb.nøkler 6 – 19, 21-22-24 mm	MODM.440-2 1395,- 5 komb.nøkler 27-29-30-32-34 mm	MODM.440-4 1250,- 13 fastnøkler, tommer 1/4-5/16-11/32-3/8-7/16-1/2- 9/16-5/8-11/16-3/4-13/16-7/8- 15/16	
			
MODM.467FJ12 2400,- 12 skrallenøkler m. ledd 8 – 19mm + pipeadapter 1/4" og 1/2" og bitsholder	MODM.467FJU8 1615,- 8 leddet skrallenøkler, inch 15/16-3/8-7/16-1/2-9/16-5/8- 11/16-3/4	MODM.467J12 2375,- 12 skrallenøkler 8 – 19 mm	MODM.467JU12 2375,- 12 skrallenøkler, tomme 1/4-5/16-3/8-7/16-1/2-9/16-5/8- 11/16-3/4-13/16-7/8-15/16

Alle priser netto ekskl.MVA. 06/17

NICOM A/S
Stålfjæra 5
0975 OSLO

Tlf.: 22 666 777
Fax: 22 666 770

www.nicom.no
www.smarttools.no
e-mail: nicom@nicom.no

			
		MODM.R1A 1795,- ¼" pipesett, skralle R.161 R.5,5-14MM, 83SH.JP9 R.209-235-236A-240A-120A BiTS: 6KT. 3-4-5-6-7MM, Torx 15-20-25-30-40, flat 4,5-6,5-8 PH 1-2-3, PZ 1-2-36	MODM.RL1 1795,- ¼" pipesett, skralle RL.161 R.5,5-14MM, 83SH.JP9, ECR R.209-215-235-236A-240A BiTS: 6KT. 3-4-5-6-7MM, Torx 15-20-25-30-40, flat 4,5-6,5 PH 1-2-3, PZ 1-2-3
			
MODM.RL1U 2170,- ¼" pipesett, tommer, RL.171 11 korte piper, 3/16-9/16, 12kt 10 lange piper 3/16-9/16, 12kt R.210RC-217RC	MODM.RL2 2150,- ¼"pipesett, RL.171 skralle 13 piper 3,2-14mm, 11 lange piper 4-13mm, R210RC- R215RC-R217RC-R240- 83SH.JPA	MODM.RL2U 2150,- ¼"pipesett, inch, JL.161 skralle 11 piper 12kt 3/16-9/16, 18 bits, R.120-209-215-235- 236A-240A 83SH.JP8U unbrakonøkler	MODM.S1 1900,- 1/2" pipesett, skralle S.161 SH 8-19, 21-24, 27-30-32 MM S.210-215-240A-120A
			
MODM.SL1 1985,- 1/2" pipesett, skralle SL.161 SH 8-19, 21-24, 27-30-32 MM S.210-215-240A-120A	MODM.SL171-36 2380,- ½"pipesett SL.171 skralle 18 piper, 2 forlengere m.lås, ledd og T-håndtak	MODM.SL2U 2165,- ½"pipesett, tommer. SL.171 15 korte piper 3/8"-1 1/4" 7 lange piper ½"-7/8" S.210RC-215RC	MODM.SXL1 2150,- ½" pipesett 8-32 mm Teleskopskralle med lås SXL.171, Forlengere m.lås S210RC-S.215RC
			
MODM.VSEHYPB 7450,- Verktøy for el- og hybrid biler 701B,A5.5x125VE,AD2x125VE, 55.10 og 12AVSE J.151-210-215-121AVSE, piper 8-10-11-12-13-14VSE Momentnøkkel J.306-50VSE 2780,- i tillegg	MODM.ROUE-EA 1570,- 21 kraftpiper ½" 10-21,26-30-32mm <i>Forberedt plass for momentnøkkel, lange kraftpiper, hjulbolt piper, hansker og muttetrekker (luft eller ACCU)</i>	PM.384 235,- Modul for smådeler	

Alle priser netto ekskl.MVA. 06/17

NICOM A/S
Stålfjæra 5
0975 OSLO

Tlf: 22 666 777
Fax: 22 666 770

www.nicom.no
www.smarttools.no
e-mail: nicom@nicom.no

			
MOD.MI4 1050,- 202H.1/2, 208A.32CB, 263.18, 256.6, 248.4-5-6 PL.333	MOD.MI7 960,- 205C.50-208A.32CB- 248.4-5-6, 263.18-256.6 PL.333	MOD.MT1 2635,- 405MT, 405.12MT, 406MT, 406.8MT, 402MT, 433LMT PL.612	MOD.NS1 1665,- NS10A-19A,21A-24A NS215A PL.610
			
MOD.NS2 2320,- NS13A-19A,21A,22A,, 27A,30A,32A,236,237 6xENH 6-14MM 5xTorx 30-55, 3xPH2-4 PL.623	MOD.NS260 1825,- NS260A,236A 15BITS PH,PZ,UNBRAKO,TORX PL.380	MOD.PC 1095,- 177A.18, 197A.18 179A.18, 199A.18 PL.322A	MOD.PCSN 975,- 177A.13, 177A.18 179A.13, 179A.18 PL.332A
			
MOD.PR4 780,- 180.CPE, 501.AMP PL.330		MOD.PR8 780,- 180.CPE 500 PL.330	MOD.PR9 905,- 181A.25CPE 501 PL.330
			
MOD.PR11 865,- 181A.25CPE T5.L PL.330	MOD.PR12 780,- 181A.25CPE 580.10 PL.330	D.83C 4995,- 28 deler sett for Mc.Pherson støtdemper service PL.647	MOD.RL1U 1250,- ¼"pipenøkkelsett, tommer, 6kt RL.161,R5,5-14, ECR R209-215-240A-120A-235-236A 82H.1,5-10, bits flate 4,5-6,5 Bits PH og PZ 1-2-3

Alle priser netto ekskl.MVA. 06/17

			
MOD.CPE 805,- 185.20CPE, 187.18CPE, 192.16CPE PL.627	MOD.CPE5 1610,- 185.20CPE, 192.16CPE 195.20CPE, 181CPE, 501 PL.657	MOD.E20L 960,- EHL204,205,206,207,208,210 EVL205,206,208,210 EXL230,240,245,250 EXRL110,115,120,125,130, 140, SJ236,R235N,S236N PL.624	MOD.E41 1210,- ED101T,102T,103T EH104,105,106,107 EH204L,205L,206L,207L,208L,210L. EH208,210 EV205L,206L,208L,210L EV206,208,210 EX230L,240L,245L,250L EX245,250,255 PL.621
			
MOD.HLB 1595,- J.HLA 7-11MM S.HLA 12-19MM PL.609	MOD.J1 1485,- 3/8" pipesett, 6kt JH.8-19,21-22, J.161-210-215-120-240 PL.322A	MOD.J2 1485,- 3/8" pipesett. 12kt tommer J.5/16-7/8, J161-J210-J215-J120A-J240A PL.601	MOD.J6 1530,- 3/8" pipesett m. RotoTwist skralle J.360. JH.8-19,21,22 J.210A-215-240A PL.674
			
MOD.JL1 1485,- 3/8" pipesett, 6kt JH.8-19,21-22, JL.161 J210-215-120A-240A-232-235 PL.686	MOD.JL112 1485,- 3/8" pipesett, 12kt J.8-19,21-22, JL.161 J210-215-120A-240A-232-235 PL.686	MOD.JL2 1560,- 3/8" pipesett, 6kt. J.8-19,21,22, J.232,236,240 Skralle + 2 forlengere m. Lås PL.686	MOD.JL2U 1560,- 3/8" pipesett, 6kt., tommemål PL.692
			
MOD.K1 3275,- K.HB34,35,41,46,50,55 K.151B-210B-120B-230B PL.324	MOD.KL2 3750,- K.HB34,36,41,46,50,55 KL.161-210B-240A PL.662A	MOD.LIM 730,- 5 filer m. håndtak Flat-rund-halvrund- 3kant -4kant	MOD.MET 2275,- 805.1, 806F, 814M, 804 PL.634

Alle priser netto ekskl.MVA. 06/17

NICOM A/S
Stålfjæra 5
0975 OSLO

Tlf.: 22 666 777
Fax: 22 666 770

www.nicom.no
www.smarttools.no
e-mail: nicom@nicom.no

				
MOD.A5 750,- 10 Protwist trekkere PZ og PH stjerne PL.677	MOD.A6 820,- 10 ResiTorx® trekkere T6-T40 AEX.6x35-7x35-8x75 ANXR10x75-15x75-20x100- 25x100-27x100-30x125-40x150 PL.678	MOD.A7 565,- 8 Protwist trekkere, AN3,5x75-4x100-5,5x150- 6,5x150-AWH8x175-ANP0x75- AND1x100-2x125 PL.625	MOD.AN XR 665,- 7 ResiTorx® trekkere ANXR10x75,15x75, 20x100,25x100,27x100, 30x125,40x150 PL.327A	
				
MOD.BJC 1830,- Tennplugg modul 3/8" 14-16 mm kort/lang 18-21 mm kort, DM.20 PL.669A	MOD.BJ-GM 3180,- 11 delers 3/8" sett for tennplugg 14-1621 mm glødeplugg 8-9-10-12mm J.161-D.110 PL.661A	MOD.BRA 1980,- D110,B10R8L,B10R9L, B10R10A,B10R12AL D133A6 PL.667	MOD.BSB 1345,- Tennplugg modul 1/2" 16-18-21mm, 16mm lang DM.120 PL.668A	
				
MOD.CAR1A 2050,- Hammer 861D.RPC Mothold 902B-909A-906A PL.396B	MOD.CAR2 6995,- 259-209.50-225.j3-850.S350- 851B-860H.28-861D.30-862D.60- 867D-870B-871B.55-874A-875.3- 906A PL.679	MOD.CARA 4490,- 225.J3-259.P-501-850.S350- 851B-862D.60-875.3-875.4-884B- 874A PL.379B	MOD.CDX 1590,- CDX piper 8-22,24,27 mm skralle, 2 forlengere, ledd og 2 overganger PL.355	
				
MOD.CG 1075,- 249G.2-3-4-5-6-8mm 247G.4-5-6-8mm 225.G6 PL.334	MOD.CG1 1415,- 249G.12-14-16mm 263G.19-20-22 265G.18 PL.611	MOD.CH 1495,- D.34B7L,B9L,B10L,B12L, B14L,B16L, B.14LB SV6LB,8LB,10ELB,12EL, JTX8,10, stx12,14,16,18,20 SX55LA,70LA SHP6LA,8LA,10LA,12LA PL.663	MOD.DFD 1650,- Modul for skivebremser 13 deler PL.685	MOD.DFT 2150,- Modul for trommelbremser 5 deler PL.684

Alle priser netto ekskl.MVA. 06/17

NICOM A/S
Stålfjæra 5
0975 OSLO

Tlf.: 22 666 777
Fax: 22 666 770

www.nicom.no
www.smarttools.no
e-mail: nicom@nicom.no

				
MOD.440-1 1180,- 16 nøkler 6-19,22,24mm PL.670	MOD.440-1XL 1320,- 17 nøkler 6-19,21,22,24mm PL.313	MOD.440-2 930,- 27-29-30-32mm PL.314A	MOD.440-2XL 1200,- 27-29-30-32-34 mm PL.671	
				
MOD.440-4 1095,- 13 nøkler tommemål 1/4-15/16" PL.673	MOD.467FJ12 2315,- 12 leddet skrallenøkl. 8-19mm, 3 adaptere bits-pipe PL.680	MOD.467J12 2135,- 12 Skrallenøkler 15° 8-19mm PL.652	MOD.467J13 2625,- 12 nøkler 8-19mm Kort nøkkel 467.10 3 adapter bits-pipe PL.682	
				
MOD.467XL 3010,- 6 Skrallenøkler 15° 21,22,24,27,30,32mm PL.653	MOD.467RJ12 2525,- 12 skrallenøkler med Rapid gaffel. 8-19 mm PL.652	MOD.467RJ14 3130,- 14 skrallenøkler med Rapid gaffel. 8-24 mm PL.690	MOD.601 1720,- 601, 660A.10. 234.S, 803.300M, 1712 5 filer 200 mm m.skaft PL.335	
				
MOD.A1 605,- 8 Protwist trekkere AN3x75,3,5x100,4x100, 5,5x125,AWH6,5x150, 8x175,ANP1x100,2x125 PL.625	MOD.A1VE 695,- 8 stk 1000V trekkere AVE3,5x100,4x100, 5,5x125,AP- VE1x100,2x125 AD-VE1x100,2x125 PL.625	MOD.A2 640,- 8 Protwist trekkere AN2x75,2,5x75,ANP0x75, AND0x75,1x100,2x125 AWPH og AWDH3x150 PL.361	MOD.A3 560,- 8 Protwist trekkere AN4x25,5,5x35,ANP0x75, 1x125,AND0x75,1x100, 2x125,2x35 PL.326	MOD.A4 710,- 9 Protwist trekkere, flate PL.676

Alle priser netto ekskl.MVA. 06/17

NICOM A/S
Stålfjæra 5
0975 OSLO

Tlf.: 22 666 777
Fax: 22 666 770

www.nicom.no
www.smarttools.no
e-mail: nicom@nicom.no

			
MOD.43 1195,- 7x9,8x10,11x13, 12x14,17x19 PL.635	MOD.44-1 750,- 6x7,8x9,10x11,12x13,14x15 16x17,18x19,21x23,22x24 PL.315 MOD.44-2 635,- 26x28,27x29,30x32 PL.316	MOD.55-1 895,- 7 ringnøkler 6x7,8x9,10x11,12x13,14x15 16x17,18x19 PL.317A	MOD.55-2 750,- 21x23,22x24,26x28 PL.318A
			
MOD.55-3 1030,- 7 ringnøkler, tommemål 1/4x5/16-11/32x13/32-3/8x7/16 1/2x9/16-5/8x11/16-19/32x25/32 3/4x13/16 PL.600A	MOD.64J7 1590,- 7 rette skrallenøkler 6x7,8x9,10x11,12x13, 1415,16x18,17x19 PL.608A	MOD.65J7 2070,- 7 skrallenøkler 15° 6x7,8x9,10x11,12x13, 1415,16x18,17x19 PL.608A	MOD.66A-1 1775,- 6 leddnøkler 6x7,8x9,10x11,12x13, 14x15,16x17 PL.319A
			
MOD.66A-2 1320,- 3 leddnøkler 18x19,20x22,21x23 PL.320	MOD.75-1 1120,- 10 vinklede nøkler 8,10,11,12,13,14, 16,17,18,19 mm PL.625	MOD.84TZS 640,- 7 unbrakonøkler 84TZ.3mm 84TZS. 4- 10mm.M.kulehd PL.329	MOD.89TX 755,- 7 Torx®trekkere T10-15-20-25-27-30 og 40 PL.328
			
MOD.97 1135,-	MOD.99B 2700,- 7 Lange T-Nøkler m. ledd 7,8,10,11,13,17,19mm PL.304	MOD.208 3640,- Hjulskiftnøkkel 77ATOD Momentnøkkel S.208- 200. Piper NSB17-19-21 SH.17-19-21 PL.337A	MOD.234 1410,- 257G, 234, 893.316, DELA1051.05, D.1885.00 DELA1223.02 PL.633

Alle priser netto ekskl.MVA 06/17

NICOM A/S
Stålfjæra 5
0975 OSLO

Tlf: 22 666 777
Fax: 22 666 770

www.nicom.no
www.smarttools.no
e-mail: nicom@nicom.no

			
MOD.R1 1320,- 1/4" pipenøkkelsett R.5,5-14;R120,R161,R209, R215,R226,R235,R240 82H2-10,ES4,5-6,5-8 ED1-2,EH3-4-5-6 PL.321	MOD.R3 1320,- 1/4" pipenøkkelsett, tommer R.3/16-1/2, R120,R160,R209, R215,R226,R235,R240, 82H.5/64-3/8,EH1/8-7/32 PL.603	MOD.R5 1825,- 1/4"pipenøkkelsett, metrisk R.5,5-14,EP1-3,ED1-2,ES6,5-8, EH3-7,EXR10-40,83SH1,5-10, 89S10-45, R209,215,240,236, 235,120,161 PL.658	MOD.RL1 1320,- 1/4"pipenøkkelsett, metrisk, 6kt RL.161,R5,5-14, ECR R209-215-240A-120A-235-236A 82H.1,5-10, bits flate 4,5-6,5 Bits PH og PZ 1-2-3 MOD.RL112 1250,- Med 12kt piper PL.321
			
	MOD.S1 1595,- 1/2" pipenøkkelsett S.10-19,21-24,27,30,32 S161,210,215,240 PL.323	MOD.S161-212U 1750,- 1/2" pipenøkkelsett,tommer S3/8-3/4,13/16-7/8 S.161,210,215,240 PL.604	MOD.SL161-46 1950,- 1/2" pipesett 6kt SL.161,SH10-19-21,24,27,30,32 S.230-215-240A-230-232B MOD.SL112 1950,- Med 12kt piper PL.687
			
PL.695	MOD.SHPA 1980,- SHP5ELA,6LA,7LA,8LA SV6LB,8LB,10LB,12LB SX40LA,45LA55LA,70LA PL.336	MOD.TX1 1320,- 59TX.E6xE8,E10xE12 E14xE18,E20xE24 JTX8-16,STX18-20 EXR110-140,EX240-255 R235,J235,S236 PL.360	MOD.U306 3470,- U.14L U.306A140 3xU306G2 innv. 3xU306G10 lang utv. PL.354
			
MOD.U48A 1610,- D.105-8-10-10,5-13,1 D.107-8-10-12-13-14-17 D.106-10, D.109-10, D.120-16 VS.230 PL.399	MOD.VE 1040,- 180VE, 391.16VE 194.17VE PL.622	MOD.Y105 1355 Y.105B 600 NAGLER Std.4x8,4x10,4,8x8,4,8x10 Sort4x8,4x10 PL.377	PL.384 185 Tomt modul for smådeler

Alle priser netto ekskl.MVA. 06/17

					
VR.R127 1575,- Mini luftskralle 1/4	VR.J154 1575,- Mini luftskralle 3/8		VR.R227 1795,- Luftskralle lang 1/4	VR.J254 1795,- Luftskralle lang 3/8	
					
VR.S3136 2300,- luftskralle 1/2			NJ.A1700F2 3450,- Vinkel trekker 3/8 215Nm	NS.A1700F2 3450,- Vinkel trekker 1/2 244 Nm	
					
NJ.3000F 2995,- 3/8 710 Nm	NS.1600F 1995,- 1/2 860 Nm	NS.3000F 2995,- 1/2 1700 Nm	NK.3000F 6995,- 3/4 2215 Nm	NM. 3000F 9995,- 1" 3390 Nm	NM.3030LF 995,- 1" 3390 Nm
					
V.402F 1995,- Båndsliper 330mm	V.403F 2950,- 520mm	V. 401F 1250,- Slipemaskin	V.252F 2650,- Orbitalsliper Ø152	V.DGA305F 1250,- Luftsliper 90 grader	V.DG300F 1100,- Luftsliper rett
					
V.DGE300F 1250,- Lufts sliper lang		V.DGA310F 1250,- Luftsliper 120 grader	V.472F 2600,- Vinkelsliper 127mm	V.500F 4800,- Pusser for rust/klistremerker	
					
V.320FH 750,- Meiselhammer	V.820F 3350,- Graverpen	V.999A 295,- Blåse spiss	V.775F 1950,- Karosserisag proff	V.770F 1400,- karosserisag	

06/17

 Alle priser **netto** eks.MVA



DLS.42

Facom verktøy for å fjerne/demontere sving armene. Fjerne begge sider samtidig.

kr 4950,-



CR.S20

Facom arbeids plattform.

Maks 150 kg. 380 x 1250 x 493 mm

kr 1095,-



CR.D4

Facom sett med 4 skraper.

kr 335,-



CR.D5

Facom sett med 5 stk plast brekkjern for klips og interiør m.m.

kr 335,-



DF.17-P

Facom calipter tang for bruk på luft. Leveres i koffert med multiadaptere som fungerer på alle biler.

kr 2550,-



DM.MUB-A

Facom fleksibel slangeklemmetang. Ny og forbedret modell.

kr 795,-



DM.U0F

- Universal olje/frostveske påfyller
- Min 34mm
- Maks 60 mm

kr 460,-



BAT.TEST

- 6-12 V
- Printer
- Avtakbare klyper
- AGM, EFB, Liquid, GEL, VLRA

kr 4200,-



DCR.HR-100

Avdrager for ødelagte glødeplugger. Virker med 8,9 og 10 mm plugger

kr 5795,-



DM.SPRAY

Fyll på renseveske eller lignende og deretter fyll på luft slik at det blir en sprayflaske. Kan også bare fylles på luft for støvblåsing

kr 745,-



DM.PS4

plast spaker for å separere motor/girkasse o.l.

Kr 225,-

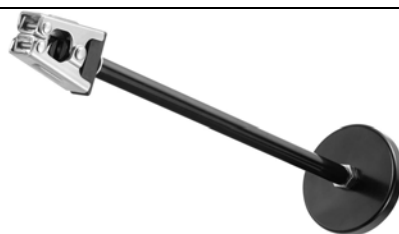

CR.SMP

- kraftig magnet og klype
- For bruk i lakkboks
- Holder 0,6 Kg
- For speil, bensinlokk o.l

Kr 350,-



DEP.T-J2

Oljefilter kopper for Toyota

Kr 395,-



217.J2

Sett for å montere lager og foringer på bil/motorsykkel. 2 størrelser 9.5 til 50 mm og 18-90 mm

kr 2575,-



DCR.ICA

Sett for å rense dyse sete

Kr 1160,-



DCR.IP

Komplett dyse avtrekker sett

Kr 6950,-



911PB

Kompresjons tester for diesel m/utskrift

Kr 7995,-



912PB

Kompresjons tester for bensin m/utskrift

Kr 5575,-



DX.V12

- 0-49V DC
- 0-40MΩ
- PWM/MLI detektor
- Linjetest

kr 1250,-



DX.SET

Ledningsett til multimeter

kr 1250,-

E010131 Kr. 5.990,- Verktøyvogn tom. Vognen har sentrallås og store hjul – 2 svingbare – 1 med lås. Gummiplate på arbeidstoppen. 8 skuffer. Plass til 4 moduler per skuffe. Kompatibel med Facom's moduler.		E010130 Kr. 4500,- Verktøyvogn tom. Vognen har sentrallås og store hjul – 2 svingbare – 1 med lås. Gummiplate på arbeidstoppen. 7 skuffer. Plass til 3 moduler per skuffe. Kompatibel med Facom's moduler	
E030715 1365,- 1/4" sett 67 deler		E194680 690,- 1/4" sett 45 deler	
E034853 2010,- 1/4" + 3/8" sett 62 deler		E194678 739,- 3/8" sett 20 deler	
E031821 1698,- 3/8" sett 50 deler		E194677 705,- 1/2" sett 21 deler	
E032924 785,- 1/2" sett 10 deler		E032201 581,- 1/2" langpiper 10-24 mm	
E032922 1925,- 1/2" sett 40 deler		E040601 1126,- 1/2" kraftpiper 17 deler	
E041644 1930,- 1/2" slagpisesett 33 deler		E041604 1625,- 1/2" hjulbolt-kraftpisesett	
E194937 648,- 16 fastnøkler 8-24mm		E110302 373,- Fastnøkler 27-32 mm	
E194938 1214,- 12 skrallenøkler		E111100 910,- 7 skrallenøkler + skiftenøkkel	

09/16

Alle priser **netto** eks.MVA

E111220 464,- 11 dobb.gaffelnøkler	E111710 495,- 8 dobb.ringnøkler 6-22mm	E121105 750,- 74 delers Torx-unbraco-bits	E020611 355,- 4 filer
E194940 338,- 8 skrutrekkere	E194941 298,- 6 Torx® trekkere	E121201 430,- 8 unbracnøkler	E121213 338,- 7 Torx® nøkler
E150802 498,- Pen-hammer modul	E150803 460,- Kulehammer modul	E194945 472,- 4 tenger	E194943 710,- 4 låseringstenger
E194944 600,- 2 griptenger	E080801 598,- Tangsett	E200313 1185,- Tenn- og glødepluggmodul	E200245
	E090302 960,- Platearbeidsett	E142401 790,- Platemodul 7 deler	E010516 77,- Smådelmodul

09/16

Alle priser **netto** eks.MVA

	<p>E201408 kr.1350,- Oppladbar SMD LED arbeidslampe 180 Lux, Li-Ion batterier Justerbar lengde 1,14-1,90 meter Ladetid 3,5 time/lystid 4timer Velegnet under panseret på bilen</p>	
		
<p>E010128 76,- Magnetskål Ø 135mm, Høyde 35-92 mm E010129 152,- Magnetskål Ø 225mm, Høyde 42-130mm</p>	<p>E418226 kr. 81,- 6 dorer 2 – 8 mm. Leveres i plastbox</p>	<p>E150103 kr. 108,- 50mm 500 gram E150105 kr. 154,- 100mm 1000 gram</p>
		
<p>E200101 kr. 1389,- 2 Tonn, vekt 25 kg Løftehøyde max. 413mm, min. 108mm Løftepad m.gummi, metallhjul</p>	<p>E200102 kr. 3240,- Lav garasjejekk 80mm – 520mm. Lengde 870mm Hurtigløft, gummipad, metallhjul</p>	<p>E200105 kr. 390,- 3 Tonn Støttebukker H. 292-432 mm. Enkel justering, Pris for 1 par</p>
		
<p>E200229 kr. 165,- Selvjusterende oljefilternøkkel 65-120 mm</p>	<p>E200228 194,- Lav tømmefat for olje 8 ltr.</p>	<p>E200502 700,- Lav tømmefat for kjøleveske o.lign, 30 ltr Mål: H125xL850xB600 mm</p>
		
<p>E200201 1095,- 27 kopper + 1 universal oljefilterkoppsett. 3/8" firk.. Med overgang til 1/2" skralle</p>	<p>E200203 585,- 13 delers bitsett for oljeplugg. 3/8" firk.</p>	<p>E117117 160,- Oljefiltertang 60 – 110 mm</p>

09/16

Alle priser **netto** eks.MVA



E030118	¼" Torx® pipe T6	15,00
E030119	¼" Torx® pipe T7	15,00
E030120	¼" Torx® pipe T8	22,00
E030121	¼" Torx® pipe T9	22,00
E030122	¼" Torx® pipe T10	22,00
E030123	¼" Torx® pipe T15	22,00
E030124	¼" Torx® pipe T20	22,00
E030125	¼" Torx® pipe T25	22,00
E030126	¼" Torx® pipe T27	22,00
E030127	¼" Torx® pipe T30	22,00
E030128	¼" Torx® pipe T40	22,00
E030912	3/8" Torx® pipe T8	33,00
E030913	3/8" Torx® pipe T10	33,00
E030914	3/8" Torx® pipe T15	33,00
E030915	3/8" Torx® pipe T20	33,00
E030916	3/8" Torx® pipe T25	38,00
E030917	3/8" Torx® pipe T27	38,00
E030918	3/8" Torx® pipe T30	38,00
E030919	3/8" Torx® pipe T40	38,00
E030932	3/8" Torx® pipe T45	46,00
E030920	3/8" Torx® pipe T50	46,00
E030921	3/8" Torx® pipe T55	48,00
E031918	½" Torx® pipe T20	46,00
E031919	½" Torx® pipe T25	46,00
E031920	½" Torx® pipe T27	46,00
E031921	½" Torx® pipe T30	46,00
E031922	½" Torx® pipe T40	53,00
E031923	½" Torx® pipe T45	53,00
E031924	½" Torx® pipe T50	61,00
E031925	½" Torx® pipe T55	69,00
E031926	½" Torx® pipe T60	85,00
E030101	¼" unbrakopipe 2 mm	22,00
E030102	¼" unbrakopipe 2,5 mm	22,00
E030103	¼" unbrakopipe 3 mm	22,00
E030104	¼" unbrakopipe 4 mm	22,00
E030105	¼" unbrakopipe 5 mm	22,00
E030106	¼" unbrakopipe 6 mm	22,00
E030107	¼" unbrakopipe 7 mm	22,00
E030108	¼" unbrakopipe 8 mm	25,00
E030901	3/8" unbrakopipe 3 mm	38,00
E030902	3/8" unbrakopipe 4 mm	38,00
E030903	3/8" unbrakopipe 5 mm	38,00
E030904	3/8" unbrakopipe 6 mm	38,00
E030905	3/8" unbrakopipe 7 mm	38,00
E030906	3/8" unbrakopipe 8 mm	42,00
E030907	3/8" unbrakopipe 10 mm	46,00
E030908	3/8" unbrakopipe 12 mm	46,00
E031901	½" unbrakopipe 4 mm	22,00
E031902	½" unbrakopipe 5 mm	46,00
E031903	½" unbrakopipe 6 mm	46,00
E031904	½" unbrakopipe 7 mm	46,00
E031905	½" unbrakopipe 8 mm	49,00
E031906	½" unbrakopipe 9 mm	49,00
E031907	½" unbrakopipe 10 mm	49,00
E031908	½" unbrakopipe 12 mm	73,00
E031909	½" unbrakopipe 14 mm	73,00
E031910	½" unbrakopipe 17 mm	97,00
E031911	½" unbrakopipe 19 mm	97,00





Se mer: <http://www.expert-tool.com>

E113901 kr. 132,- 19 deler, bits og magnetisk holder	E131701 kr. 244,- 49 deler, flate, stjerne, Torx, unbrako, holder m.lås	E131702 kr. 318,- 32 deler, kompaktskralle og bits	E131705 kr. 399,- 39 deler, kompaktskralle, piper 6-13mm og bits
PH og PZ 6 PKN		UNBRAKO 6 PKN.	
E113685 PH1 kr. 30,-	E113650 HEX 2 MM kr. 30,-	E117771 T6 kr. 30,-	
E113686 PH2 kr. 30,-	E113651 HEX 2,5 MM kr. 30,-	E117772 T7 kr. 30,-	
E113687 PH3 kr. 30,-	E113652 HEX 3 MM kr. 30,-	E117773 T8 kr. 30,-	
E113631 PZ1 kr. 30,-	E117768 HEX 4 MM kr. 30,-	E117774 T9 kr. 30,-	
E113632 PZ2 kr. 30,-	E113654 HEX 5 MM kr. 30,-	E117775 T10 kr. 30,-	
E113633 PZ3 kr. 30,-	E113655 HEX 6 MM kr. 30,-	E117776 T15 kr. 30,-	
	E113656 HEX 7 MM kr. 30,-	E117777 T20 kr. 30,-	
	E113657 HEX 8 MM kr. 34,-	E117778 T25 kr. 30,-	
	E113658 HEX 10MM kr. 47,-	E117779 T30 kr. 30,-	
		E117780 T40 kr. 30,-	
		TORX® 	
E160901 kr. 130,- 5 skrutrekkere meget bra kvalitet Flate: 3,5x75-4x100-5,5x125 PH 1x100--2x125	E160905 kr. 295,- 10 skrutrekkere meget bra kvalitet Flate: 2,5x75-3x75-4x30-4x100-5,5x125 PH 0x75-1x100-2x30-2x125	E160908 kr. 284,- 7 Torx trekkere meget bra kvalitet T10 – T40	E160910 kr.210,- 6 skrutrekkere 1000 V meget bra kvalitet 4 flate – 2 PH
			E160911 kr. 210,- 6 skrutrekkere 1000 V meget bra kvalitet 4 flate – 2 PZ

11/2015

Alle priser **netto** eks.MVA

			
<p>E031803 kr. 332,- Tommemål 13 piper 3/8" firk. 1/4" – 1" levert på skinne</p>	<p>E032805 kr. 230,- 1/2" latmannsarm 600 mm E033804 kr. 838,- 3/4" latmannsarm 1020 mm</p>	<p>E113238 kr. 530,- 16 Fastnøkler 8 – 24 mm E110306 kr. 941,- 21 Fastnøkler 6 – 32 mm</p>	
			
<p>E110304 kr. 197,- 7 korte fastnøkler 11-12-13-14-15-16-17-19mm</p>	<p>E111107 kr. 719,- 7 skrallelønker 8 – 19 mm</p>	<p>E110303 kr. 362,- 12 Lange fastnøkler 8 – 19 mm E117702 kr. 65,- Lang fastnøkkel 22mm</p>	
			
<p>E080805 kr. 488,- 4 standard tenger</p>	<p>E121102 kr. 126,- Torxsett T10 – T40</p>	<p>E140601 kr. 225,- Skyvelære 150 mm Gradering 0,05mm</p>	<p>E051401 kr. 98,00 Teleskopspeil med LED lys Lengde 280-875 mm. CR2032 batteri inkl.</p>
			
<p>E010136 Kr. 1495,- Tralle i ALU/Plast kap.ca 150 kg Mål 752x470x965mm. 4 svinbare hjul-1 m.lås Leveres flatpakket</p>	<p>E010106 Kr. 1620,- Solid tralle tåler 200 kg. Hyller med kanter og gummimatter Mål ca. 885x485x820 Leveres flatpakket</p>	<p>E200135 625,- Sammenleggbare 4-hjuls tralle kap150 kg. 815x738x479 mm 2 svingbare-2 faste hjul</p>	<p>E200136 650,- Sekketralle kap 200 kg 425x555x1130mm, luftgummihjul</p>

09/16

Alle priser **netto** eks.MVA

		
<p>E010305 kr. 190,- Plast verktøykasse med faste og løse rom til småting. Innvendig løst verktøybrett. Håndtak kan legges flat. Mål. 490x285x240mm</p>	<p>E010601 kr. 435,- Expert verktøyveske med hel bunn. Mange lommer både utvendig og innvendig. Plass til baufil/sag. Med bærerem og stoff lokk. Mål L500x B215 x H400mm</p>	<p>E220107 Kr. 3540,- ALU koffert med 141 verktøy Innhold ¼" og ½" pipesett, komb.nøkler, tenger, dorer, hammer, skiftenøkkel, baufil, skrutrekkere, bitsset, unbrakosett, Torxsett, skyvelære, rissenål, wire-stripper, kabelskotang, spennings tester</p>
		
<p>E030700 kr. 381,- ¼" sett 19 deler, piper 4 – 14 mm Skralle og forlengere, ledd</p>	<p>E194672 kr. 441,- ¼" sett 34 deler, piper 4 – 14mm. Skralle, forlengere, ledd og bits</p>	<p>E030702 kr. 564,- ¼" sett 42 deler, piper 4 -14mm Skralle, forlengere, ledd, bitspiper m.m.</p>
		 <p>Lokket på Expert boksene kan enkelt tas av, slik at boksene kan brukes i t.eks.verktøyvogne. Størrelsen på boksene er modulbasert og tilpasset skuffene i Expert og Facom verktøyvogne</p>
<p>E031805 kr. 589,- 3/8"sett 22 deler. 12kt piper 6-24mm Skralle, forlengere, ledd, bitsholder</p>	<p>E032908 kr. 1189,- ½" sett 42 deler. 6kt. Piper korte 8-32mm, lange 12-24mm Skralle, forlengere, T.håndtak, ledd m.m.</p>	
		
<p>E200513 kr. 1305,- Bitspiper med spesialprfiler. 29 delers ½"fir.  7 deler ¼"fir.</p>	<p>E200514 kr. 1095,- ½" Torx® bitssett 32 deler T20 – T70 lenger 55-100-140-200 mm</p>	<p>E200515 995,- 26 delers ½" Spline sett</p> <p>E200516 k 995,- 30 delers ½" unbrakosett</p>



Se mer: <http://www.expert-tool.com>

 <p>Noen av pipene er 6.kant innvendig</p>			
Tennpluggpiper stk. 63,- 3/8" firk. Med gummiinnsats E200301 14 mm E200302 16mm E200303 21mm	E200501 kr. 1466,- 7 Tenger for slangeklemmer	E201702 kr. 590,- 8 stk stopperklemmer for metallrør – drivstoff-AC- bremser	E201203 kr. 150,- 6 plast brekkjern
		 	
E200901 785,- Bremselufter m. tank 3 ltr Koples på trykkluft 6-10 bar	E200902 274,- Flaske for automatisk påfylling, 1 ltr	E200903 kr. 1075,- Bremsesveske tester for DOT 4 og 5,1. Sonde på spiralslange 1,5 m. Batteri 9V	
			
E194676 320,- Lange tynnveggede 1/2" kraftpiper m. beskyttelse for hjulbolter. 17 – 19 -21 mm	E201105 kr. 820,- Spesialpiper for skadde bolter og muttere. Konisk innerprofil grov og fin. 17-19-21mm + forlenger	E200401 kr. 2350,- 12V BOOSTER, 840-2200A28 qmm kabler, elektronikk beskyttet, ladeindikator, batteri Exodus PRO-22AGM	
			
Art E201100 kr1065,- Kuleleddavtrekker 3 stk. Ø24-28-34mm	E201510 kr. 110,00 Pusserarm avtrekker	E201509 299,- 3 spesialskraperer for lys-og regnsensorer o.lign	E200306 50,- Stålbørste – til bremsekalipere etc

09/16

Alle priser **netto** eks.MVA

	027295 Flare Master II 4,75 mm Matrisene festes med lynkopling, forsterket pressbøyle. Inkl.rørkutter, rørbøyer, avgrater	2465,00
	027296 Flare Master II 4,75 og 6 mm Som over, men med matriser til både 4,75 og 6 mm	2850,00
	027266 6mm matrise oppgradering av 027295	495,00
	027275 Matrise for oppgradering til stålrør 4,75mm	755,00
306620 9695,00		
EPB service og reset tool Dekker 25 merker-140 modeller. Utskiftning-kalibrering bremseskiver, bremseveske- Leser og sletter koder + mange andre funksjoner		
		
	08529500 Kr.1495,00 Sett for foringer	
	ABS sensor Reamer Stk 1495,00 036701 15 x 23mm Universal 036702 18 x 23mm VW 036703 18 x 34mm VAG/Audi	
		
	014125 Kr.1190,00 Gjengerep.sett for Ox/Lambda sonder. M18x1,5mm. Med nødvendig verktøy og 5 gjengeinnsatser. 014126 Kr. 650,00 Pakke med 10 gjengeinnsatser	

10/2015

 Alle priser **netto** eks.MVA

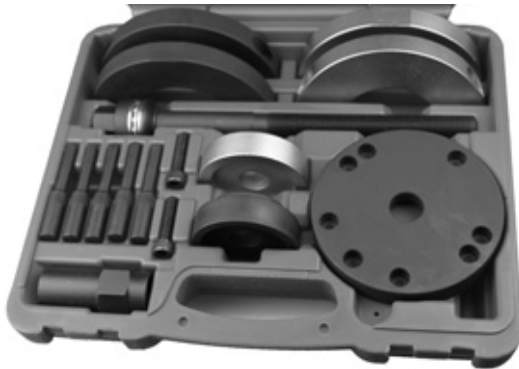

REMOVAL



INSTALL

081235	62mm Audi A2, VW Lupo	kr. 2950,00
081245	66mm Fabia, VW Fox, Polo	kr. 2950,00
081255	72mm Flere modeller VAG	kr. 2950,00
081265	78mm Ford, Mazda, Volvo	kr. 3595,00
081285	82mm Ford, Volvo	kr. 3795,00
081275	85mm VW Touareg, transp.	kr. 3990,00

Wheel Hub Bearing Unit Removal:

Using the 08125500 kit makes it possible to safely remove the old unit in-situ. It is critical that the old unit is removed at the correct angle, to prevent damage to the housing.

Wheel Hub Bearing Installation:

It is necessary to ensure that there is no damage to the locking ring when fitting new units into the bearing housing. If the locking ring becomes damaged, there is a high risk that the bearing and hub will become separated, causing premature failure.

NOTE: The Wheel Hub Unit **MUST** be pushed on the outer bearing ring, behind the locking crown. Using a press on the centre flange will cause premature bearing failure, or destroy the bearing whilst installing.



127306

Navavtrekker med både hydraulisk og slagspindel. Normalt brukes hydraulisk. Ved vanskelige tilfeller brukes slagspindel. Kan brukes med 3 – 5 armer.

Kr. 2995,00



081000 Spesial lageravtrekker

Universal lagerring trekker 40-60 mm
Skarpe tenne "skjærer" seg inn bak ringen
Konstruksjonen sikrer jevn belastning på alle punkter

Kr. 3500,00

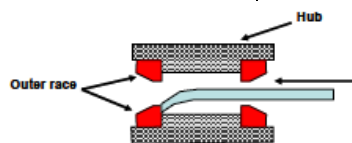

081200 Universal hjullagersett

Universalsett for montering-demontering av hjullagere direkte på bilen – tidsbesparende.

Kr. 3750,00



081003

Spesial meisel for atskillelse av lagere i nav.

Kr. 595,00



080850 Kr. 950,00

For detecting faults in:
Wheel bearings
Suspension joints and suspension struts
Stabilizers, bushes and ball-joints
Steering gear and links
The tool creates a rocking motion in any direction (forward angle, side angle etc) in order to detect movement in steering and suspension components



080800 Kr. 2495,00

For lowering of the suspension arms and separation of suspension components. Reduced effort required due to unique design using leverage and body weight. Adjustable swing point allows for variable LH & RH applications



08565000 Kr. 1190,00

VW injector sett



383600 Kr. 4995,00

Designed to support the engine or gearbox when the engine bracket has been removed. Removes the need for using cranes, transmission jacks etc
Universal tool designed for all makes of vehicle. The unit is suspended from the chassis via the support hooks, the engine / gearbox is supported by the support pad, and is counter-balanced against the underside of the vehicle by the support arms. Fully adjustable in all dimensions
Extension : min 630mm/max 960mm, support plate 190mm



087000 Kr. 795,00

Universal tool for servicing inner tie rods on steering racks
Suitable for all types of tie rods – with flats, hex or round
Can be used directly on the vehicle
Use on vehicles with limited access to avoid need to remove rack assembly
Clamp force increases as load is applied
Suitable for diameters from 33mm to 41mm



OTC6299 Kr. 1550,00

5 delers sett med kuleledd separatorer
Åpning 17,5 – 41 mm, Lengde 300-400 mm

10/2015

Alle priser **netto** eks.MVA



087800 Kr. 5700,00

Universal pressesett med 20 hylser, 4 trappeskiver og 4 spindler med kulelager.
Hylsene innv. 34-72mm, utv. 44-82mm. Spindlene M10-M12-M14-M16 – lengde 350mm
Brukes med medfølgende spindler, i stasjonær presse eller med **HJELPEVERKTØYET** her under.



187825 Kr. 3900,00

10 tonn hydraulisk presse for hylsesett o.a.
Med ekstra lange "heavy duty" spindler og sentreringsskiver.
Standard hydraulisk tilkøpling



187000 Kr. 3780,00

Universal pressramme med SP1500 8T hydraulisk spindel.
Passer til kuleledd, foringer etc direkte på bilen eller som en mini verkstedpresse



187802 Kr. 4900,00

Universal C-klemme for bruk av hylser direkte på bilen.
Tillater bruk av muttetrekker.
Kan også brukes med SP1500 hydr. spindel



OTC 7249 Kr. 1495,00

Universal kuleledd-presse for monterings-
demontering av kuleledd-universalledd-
bremsepinner etc. Hylser 42-54-66 mm

Det gis ingen garanti/reklamasjonsrett på spindler – følg bruksanvisning vedr. smøring !

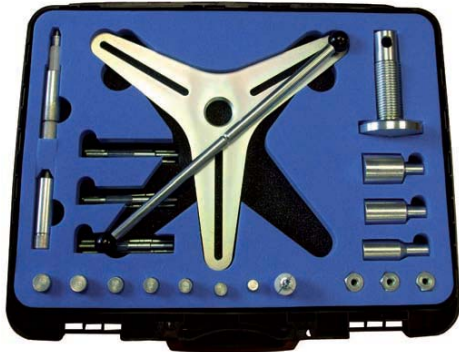

013600 Kr. 4995,00

SAC (Self Adjusting Clutch) Tool Kit

For dis-mounting and mounting SAC Clutch Assemblies to the flywheel
Approved Clutch Manufacturer's method for SAC clutches
Applications include : Alfa Romeo, Audi, BMW, Fiat, Ford, Mercedes, VW
Allows Pressure Plate to be pre-tensioned before removal and re-fitting of clutch
Avoids clutch plate distortion and accidental damage due to incorrect fitting,
and subsequent vibration and shortening of clutch life.
Includes special adjustable SAC Clutch Centering Tool
Supplied in carry case and with full operating instructions



016795V2 Kr. 1250,00

Stort 29 delers sett for montring-demontering av frihjul-dynamodrev. Passer de fleste biler som BMW-FORD-MERCEDES-RENAULT-VAG. Bosch, Marelli og Valeo dynamoer



200170 Kr. 8995,00

2-trinns lettvekt hydraulic håndpumpe. Kapasitet 10.000 Psi, ALU hus. Standard kupling. For hydrauliske avtrekkere, pressverktøy etc. Leveres i stål koffert



960150 Kr. 2250,00

Sett med 8 coiler: 15-22-26-32-38-45 + 2 stk 19mm



045500 Kr. 185,00

5 kraftige plastbrekkjern



OTC 4507 Kr. 995,00

Sett for montring-demontering av foringer og pakninger. 9 verktøy ca. 39 – 80mm + slager.



085930 Kr. 1995,00

Glødeplugg avtrekkersett For demontering av defekte og knekte glødeplugg. Passer M8x1,0 og M10x1,0 gjenger Alle nødvendige adaptere, sentreringsverktøy, gjengerensere medfølger settet.



017500V2 Kr. 2795,00

Diesel injektor rens og frese sett.

331595V2 Kr. 3600,00

Kjølesystem tester. Med trykkpumpe og 19 adaptere til de mest populære europeiske og japanske biler. Passer alle tidligere og fremtidige S-P testere

331400 Kr. 4200,00

Kjølesystem tester HGV. Metallpumpe og 7 adaptere. Passer bl.a. DAF, Iveco, MAN, Mercedes, Renault, Scania og Volvo

314700 Kr. 2380,00

Oljetrykktester m. 10 adaptere + vinkel. 1 meter slange. Manometer: 0 - 10bar, 0 - 150psi

314650 Kr. 7700,00

CRD High Pressure Test kit For testing av trykket direkte på brenselpumpen. Elektronisk sensor tester HP sensor signal. Med 5 adaptere M12x1,5 og M14x1,5. Passer de fleste applikasjoner. Leveres i koffert

314610 Kr. 3895,00

CRD Low Pressure Test kit For testing av trykket mellom tank og brenselpumpe. Med universelle og spesialadaptere bl.a. for franske biler. Leveres i koffert

314295V2 Kr. 5295,00

Diesel kompresjons tester Stort sett som passer de fleste biler. Med 5 injektor og 18 glødeplugg adaptere. For komplett liste-se web siden

314860V2 Kr. 9700,00

Bensintrykktester singel/multipoint Med 2 måleer, 12 tilkoplingsstykker og diverse slanger. Passer de fleste biler

314020 Kr. 795,00

Kompresjonstester for bensinmotorer Ekstra lang slange 460mm med 14 og mm gjenger.

314009PP Kr. 450,00

Adaptere til 314020 for hhv Ford Duratec og Renault M12

10/2015

 Alle priser **netto** eks.MVA

	<p>OTC3109 Kr. 1495,00 Auto skanner Passer OBD11 (1996-) EOBD (bensin 2001-, diesel 2004-) og hybrider. Inkl. <i>live data</i> grafer. Ideell lokalisering av problemer og til hurtig diagnose. Håndholdt vekt kun 360 gram</p>		<p>300765 Kr. 450,00 Reletester for hurtig og presis teststing av 4 og 5 pins elektro-mekaniske releer brukt i biler. Automatiske testfunksjoner. Resultater vises med en serie røde og grønne lys. Koples til bilens 12V batteri</p>
	<p>300426 kr. 460,00 Spenningstester 6 – 24V Koples til bilens batteri. 5m kabel</p> <p>Kan teste strømførende og strømløse kretser og komponenter. Ideell for å finne jordfeil. Kan sende positive/negative impulser gjennom frakoblede kretser. Viser diode og lys signaler.</p>		<p>PPLS01 Kr. 790,00 Testledningssett – mange deler Til bruk med multimeter o.a.</p>
	 <p>MV8550 Kr. 1795,00 Trykk- og vakuumpumpe Har mange bruksområder ved feilsøking på bil. Kan også brukes som bremseluffer. Leveres med mange forskjellige adaptere og slanger</p>		<p>660740 Kr. 180,00 Lufttrykkmåler BS EN 12645 62mm diameter gauge Skala: 0 – 50 psi / 0 – 3.5 bar</p>
	<p>MV7201 Kr. 1995,00 Manuell vesketømmer og fyller. Uavhengig av el og luft. 8,8 ltr tank. Brukes på motorolje, gearolje, bremseveske, kjølevæske og andre IKKE eksplosive vesker. Leveres med 3 sugerør 1,5m x 5,7-6,6- og 10 mm</p>	 <p>MV 7216 Kr. 2990,00 Fyllesett for gearolje med adapetre til BMW, Ford, Honda, Mercedes, Nissan, Toyota og >VAG. Returventil forhindrer søl. Brukes sammen med MV7201 eller tilsvarende pumpe</p>	

	<p>14020 arb.lampe kr. 395,00 Compress med COB LED. 230V lader, ladetid 4 timer, lystid 3,5 time Meget kraftig lys 300 lumen. Med magnet og belteclips. Vanntett klasse IP54, robust gummiert ABS hus.</p>
	<p>700H2 hodelykt kr. 645,00 OPPLADBAR LED lampe, brukstid 8-16 timer 2 lysstyrker maks 420 lumen, justerbar retning og zoom, rekkevidde ca. 150m, vørtett klasse IP65., justerbart hodebånd med batterikasse bak, vekt 164 gr.</p>
	<p>VAQS S7 LED penlight kr. 239,00 2xAAA batterier. Lysstid ca. 3,5 time, Flykropp aluminium, tåler fall fra 1 meter, vanntett klasse IP65, rekkevidde ca. 50 meter, 110 lumen</p>
	<p>VAQS S5 lommelykt LED kr. 350,00 LED lampe med trinnløs optisk fokus, 3xAAA batterier, Flykropp aluminium, tåler fall fra 1 meter, vanntett klasse IP65, rekkevidde ca. 250 meter, 200 lumen.</p> <p>700S8A1 kr. 890,00 Samme som over, men oppladbar 230V og USB lader i-ett, brukstid ca. 8 timer. 2 lysstyrker. 820 lumen</p>
	<p>TL1 kr. 995,- Stasjonær arbeidslampe 30 x 1W SMD LED lampe, 3300 lumens, 230V, 5 m kabel, IP54, ekstra strømuttak. Støtsikker Justerbar fot/oppheng/bærehåndtak.</p> <p>Ekstrautstyr: Teleskopisk stativ 65-158 cm TL1.S kr. 395,-</p>

10/2015

Alle priser **netto** eks.MVA

Fant du ikke det du lette etter ?

Vi kan ha det allikevel !

Spør oss:

Telf. 22 666 777

e-post: nicom@nicom.no

-
- Denne katalogen er gyldig på trykketidspunkt
 - Priser og vareutvalg kan endres uten varsel
 - Siste utgaven av katalogen med alle NYHETER ser du på

www.nicom.no

Øvrige salgs- og leveringsbetingelser finner du i omslaget